

# HOMEFIRES

## OWNERS MANUAL

### Installation & Operating Instructions

*For REAL FLAME® Gas Coal And Gas Log Fires Using Hand Held and Wall Switch Ignition with Natural Gas*

# REAL FLAME

**Please read** these instructions carefully before you begin to install this gas coal/log set.

**NOTE: Installer should leave these instructions with the customer for future reference.**

This fireplace gas coal/log set is for use with **NATURAL GAS ONLY**.

Installation and all repairs must be performed by an individual who is experienced in the installation, repair, and servicing of vented gas coal/log sets.

## W A R N I N G

**FOR INSTALLATION IN A VENTED FIREPLACE ONLY.  
THE FIREPLACE CHIMNEY MUST HAVE A PERMANENT VENT OPENING TO ATMOSPHERE.**

KEEP DAMPER WIDE OPEN WHEN IN USE.

Do not burn wood or other material in any fireplace fitted with a gas coal/log set.  
A fireguard should be used with this appliance for the protection of children and the elderly.

## F O R Y O U R S A F E T Y

**DO NOT STORE OR USE GASOLINE OR OTHER FLAMMABLE LIQUIDS  
IN THE VICINITY OF THIS OR ANY OTHER APPLIANCE.**

Young children are not allowed to operate this unit, and should be supervised  
when they are in the same room with the appliance.

Do not use this appliance or any part that has been under water.

## F O R Y O U R S A F E T Y

### WHAT TO DO IF YOU SMELL GAS:

- Open Windows
- Do not try to light any appliances
- Do not touch any electrical switch; do not use any phone in your building
- Immediately call your gas supplier from a neighbor's phone
- Follow the gas supplier's instructions

If you cannot reach your gas supplier, call the fire department.

## GENERAL INFORMATION

1. This gas coal/log set is only to be installed and used in a fully vented fireplace with a completely functional damper and chimney that is free of any obstructions. The fireplace must be constructed of non-combustible materials and approved to burn wood.
2. To operate this gas coal/log set, the flue damper **must be fully opened and locked**.
3. To be installed in a fireplace with a minimum height of 20", a minimum depth of 12" and a minimum width of 3 inches greater than the maximum width of the firegrate being installed. The flue size and height must be related to the size of the fireplace opening. For example, a big fireplace needs a tall wide flue. This gas coal/log set will normally require a chimney flue of at least 8 inches in diameter to clear its fumes. If in doubt consult your supplier. Do not use if fumes from the burner emerge into the room when the damper is fully open. This indicates that there is not adequate draft. Do not use until the problem is corrected.
4. If the fireplace has glass doors, operate the set with the doors fully opened. A fireplace screen, with an opening for introduction of combustion air, should be used when operating this appliance.
5. The nominal inlet gas pressure for this appliance is 7" water column for natural gas.
6. This gas appliance and its individual shutoff valve must be disconnected from the gas supply piping system during any pressure testing at pressures in excess of 1/2 PSIG.
7. Do not move or jostle the grate once it has been connected to the gas line.
8. The National Health and Safety Board recommend 1CO (carbon monoxide) detector for each floor.
9. The installation of the appliance and the provisions for combustion and ventilation air must conform with NFPA 54 unless otherwise noted in local building and safety codes.
10. The minimum permanent free fireplace opening required is 70 square inches.

## FIREPLACE PREPARATION

- A. Remove all ash and debris from the inside of the fireplace.
- B. Prior to connecting the gas coal/log set, make sure the gas supply is completely shut off.
- C. Prior to installation, a smoke test should be performed using a smoke pellet. The pellet is ignited at the base of the flue in the fireplace opening. **All the smoke created must be emitted at the termination of the flue without spillage from the fireplace opening or without leakage from the flue in other parts of the building. If spillage is taking place then either:**

- **the flue is partially blocked**
- **the fireplace opening is too great for the height of the flue**
- **the flue diameter is too narrow for the size of the fireplace opening**

## INSTALLATION INSTRUCTIONS

### Firegrate & Burner Pan Placement

- A. The firegrate should sit in the center back of the fireplace.
- B. The burner sits in the bottom of the firegrate with the control knob facing the **Side** (see drawing) and the LED eye of the receiver facing the **Front**.

The pan is locked into the firegrate using the fixing clips found in the box with the coals. The purpose of the fixing clips is to prevent the burner from moving. (See enclosed burner clip installation diagram.)

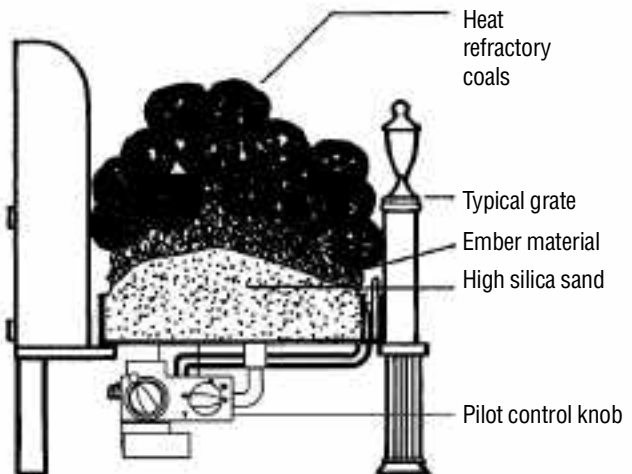

### Connecting Remote Transmitter and Receiver

These remote transmitters and receivers are intended for use only with motorized gas combination control model GV34. The receiver cable must be fully plugged into the 6.3mm and 4.8mm flat blade connectors attached to the motor (see illustration).

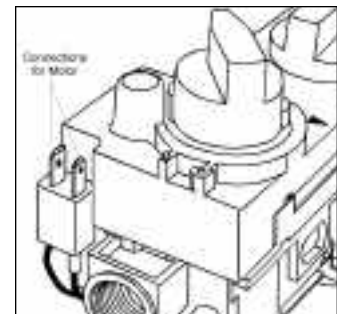

### Batteries

Insert batteries in their respective devices.

|             |             |
|-------------|-------------|
| Handset     | (1) 9V      |
| Wall switch | (4) 1.5V AA |
| Receiver    | (4) 1.5V AA |

Place the receiver (A) into the receiver shelf with the LED eye facing forward. If no shelf is provided with your burner then lay the receiver on the floor near the front of the fireplace.

**Note:**

Adequate ventilation must be provided so that the electrical components do not exceed 140 degrees Fahrenheit.

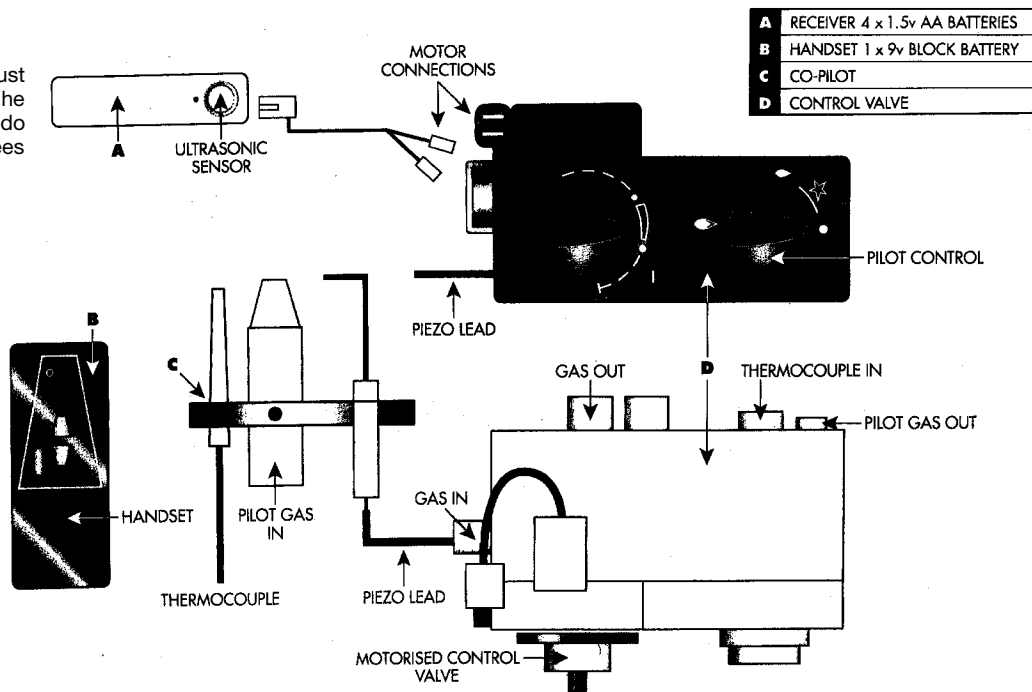
**Connecting Gas Supply to Burner Pan**

The 3/8" gas tubing will enter from the back of the fireplace and should be fitted inconspicuously at the back of the hearth. Purge the gas supply pipe to remove air and debris BEFORE connection of appliance. Run the pipe to and connect/seal it to the inlet side of the flame failure valve beneath the firegrate. Visible gas piping should be painted black. It should then be run up and connected to the inlet side of the flame failure valve beneath the firegrate.

**Note:** Use PTFE Teflon Tape NOT Pipe dope for sealing.

**Note:** For pipe sizing concerns see pipe sizing chart. Ultimately, you are responsible for installing this appliance in compliance with local building and safety codes.

**Warning:** Flexible Pipe must NOT be used.

**Sand, Ember, and Coal Placement**

- A.** Fill the burner to the top edge with the high silica sand supplied. Overfill rather than underfill.
- B.** Lay the black ember material supplied along the front edge of the fire. This gives the flickering effect. Break the tan ember material into smaller pieces and place it evenly over the rest of the sand bed, particularly piling toward the center.
- C.** If you have a log fire, place the logs in any pleasing arrangement, but stack them loosely with air spaces between the logs. For a coal fire, stack the coals as loosely as possible.

**Spillage Test:**

Test for spillage of fumes into the room with a smoke match.\* The smoke match should be moved slowly along the top of the fireplace opening just inside the fireplace. If the smoke

is drawn into the fireplace then draft is correct. If smoke can be seen coming into the room the fireplace is spilling. Disconnect the appliance and correct the flue system. (See enclosed spillage test diagram.)

\*Smoke matches and pellets are also available from HomeFires for testing spillage of fumes.

**Warning:**

Improper installation may cause Carbon Monoxide Poisoning. Carbon Monoxide, which is an odorless and colorless gas, is a by-product of combustion. Caution must be taken to insure the fireplace is properly vented when set in use. To avoid having potentially dangerous fumes enter the living area, be sure the chimney is drawing properly.

**TECHNICAL SPECIFICATIONS****Remote control package**

|                         |           |                           |
|-------------------------|-----------|---------------------------|
| Ultrasound transmission | range     | 0.5 - 10m                 |
|                         | frequency | ON 40.5kHz.<br>OFF 40kHz. |

|                     |              |               |
|---------------------|--------------|---------------|
| Ambient temperature | transmitter  | maximum 140°F |
|                     | receiver     | maximum 140°F |
|                     | conn. cables | maximum 356°F |

**Batteries**

|             | type         | recommended |
|-------------|--------------|-------------|
| Handset     | (1) 9v block | alkaline    |
| Wall switch | (4) 1.5v AA  | alkaline    |
| Receiver    | (4) 1.5v AA  | alkaline    |

**Valve GV34**

|                               |               |             |
|-------------------------------|---------------|-------------|
| Max. operating inlet pressure |               | 1/2 PSIG    |
| Capacity                      | 60,000 BTU/hr | 1" W.C. Δ P |
| Ambient temperature           | range         | 32°-176°F   |

## OPERATING INSTRUCTIONS



### Lighting your gas coal/log set (Remote Valve only)

1. Open chimney flue damper to the full open position and lock it.
2. If there is a floor key or manual gas cock in or around the hearth turn it to the full open position.

## MANUAL CONTROL

### Lighting Procedure:



1. Turn **Pilot Control** knob counterclockwise toward the ignition position  until reaching a stop, press down and hold for five seconds (only pilot gas flows).
2. Continue pressing down Pilot Control knob while turning further counterclockwise to activate **piezo ignition**, continue to hold down for 10 seconds after pilot burner has been lit. If pilot does not light, steps one and two can be repeated immediately.
3. These controls are factory preset and will not normally require additional adjustment of the pilot flame. But if field adjustment of the pilot is required, turn the **adjusting screw** clockwise to reduce flame or counterclockwise to increase flame.
4. Upon lighting, release knob and turn fully counterclockwise to the **ON**  position. Pilot gas flows and main gas flows in accordance to the flame setting that the motorized control has been set on.
5. The **Motorized Control** has a slipping clutch. This allows the motorized control to be operated by hand should the batteries become dysfunctional. To set flame height to required level turn knob either clockwise or counterclockwise to suit personal requirements.

## HANDHELD REMOTE CONTROL

1. To light the **Pilot Burner** carry out steps (1) and (2) as specified in Manual Operation above.
2. To turn the fire on and/or to increase the flame height by using the **Handset**, press both the large and small **ON** buttons simultaneously. Continue pressing until the desired flame effect is obtained. To reverse the procedure, press and hold the **OFF** button.



**Note:** When operating this appliance by the remote control it is not required to turn the pilot burner off after each and every time that the appliance is used. The operation of the OFF button shuts off the gas supply to the main burner.



## WALL SWITCH CONTROL

1. To light the **Pilot Burner** carry out steps (1) and (2) as specified in Manual Operation .
2. To turn the fire on and/or to increase the flame height by using the **Wall Switch**, simply press the  $\Delta$  until the desired flame effect is achieved. To reverse the procedure, press the  $\nabla$ .



**Note:** When operating this appliance by the wall switch it is not required to turn the pilot burner off after each and every time that the appliance is used. The operation of the **OFF** button shuts off the gas supply to the main burner.

## SHUT-OFF PROCEDURE

1. Turn Pilot Control knob clockwise until reaching stop. In this position  only pilot gas flows.
2. To shut off the valve completely, press down slightly and continue turning clockwise from the pilot position to the **OFF**  position. The safety interlock prevents re-ignition of pilot flame until the thermocouple has cooled down sufficiently.
3. Switching off the remote is not necessary.

## MAINTENANCE

Very little if any maintenance is required. The carbon deposits resulting from use is natural and adds to the realistic appearance of the set. If carbon becomes excessive it can be lightly brushed away. It is most important that you have your fire serviced once a year. This is to insure that combustion remains correct and that your flue remains clear and unobstructed so that no dangerous fumes can spill into your room. Batteries may require seasonal replacement.

## GUARANTEE/WARRANTY

*These logs and coals are guaranteed against breakage in normal use for their replacement for a period of two years from the date of purchase. All other components are guaranteed against defects in material and workmanship for a period of one year from date of purchase. This excludes variations in color which occur naturally from heat impingement. Claims under this guarantee should be accompanied by the original purchase invoice. This warranty does not apply in the case of improper installation, neglect, accident, misuse or as a result of modifications of the original product. All costs for removal and reinstallation are the expressed responsibility of the purchaser. Failure to follow all instructions in the Owner's Manual will also void this warranty. Real Flame® and S.C.S. Incorporated will not be liable for incidental or consequential damages. If this item fails due to defect in material or craftsmanship, we will replace or repair, at our option, free of charge. To order parts or obtain warranty service, call or write to SCS Incorporated.*

## SCS Incorporated

PO Box 11313  
Charlotte, NC 28220

Phone: 1-800-749-4049

Fax: (704) 376-0268

www.homefiresusa.com

email: info@homefiresusa.com

*SCS*  
Incorporated

America's Exclusive Distributor of Real Flame® Products